

VWnote

User Manual





What's this manual about?

This manual tells you about the VWnote and how to use it to take readings from VW sensors.

Who does this apply to?

Installers, field engineers and technicians who need to acquire readings from VW sensors and to maintain the VWnote system.

Welcome!

Thank you for choosing the VWnote.

This manual has been written to help you utilise all of the functions of the VWnote. Please read this manual thoroughly before use to help avoid any problems and keep it handy when using the VWnote.

VWnote

The VWnote is a handheld device which takes readings from Vibrating Wire (VW) sensors and stores them on an internal memory for retrieval later via a USB flash drive. The VWnote can read almost all commercially available vibrating wire sensors.

Built with state-of-the-art electronic components and the latest firmware technology, each VWnote comes with many powerful built-in functions. These functions will allow you to customise how readings from each sensor are taken, displayed, stored and managed in order to assure correct and repeatable readings every time.

Contents

OVERVIEW & INTRODUCTION	6
Important Information	6
Product Changes	6
Warranty	6
Disposal	6
System Description - Things You Need to Know	7
Features	7
Benefits	7
System Components	8
The VWnote	8
USB Flash Drive	8
VWnote Configuration Tool Software	8
VW Sensor Lead	9
Rechargeable Battery & Charger	9
VWnote Carry Case	9
Quick Start Guide	10
Before You Go to Site	10
When You Are In The Field	10
Back In The Office	11
DETAILED VWNOTE USER GUIDE	12
Charging the VWnote	12
Charging Unit LED Sequence	12
Connecting Sensors to The VWnote	13
VW Sensor With Built-In Temperature Sensor	13
VW Sensor Without Built-In Temperature Sensor	13
How to Use The Keypad	14
Menu Structure	16
Main Menu	16
The READ Menu	18
List Of Sites	18
List Of Sensors	18
Sensor Reading	20
Save	20
The SETUP Menu	22
Setup	22
List Of Sites	22
List Of Sensors	22
Configure A New Sensor	23
Configure An Existing Sensor	23
Flow Diagram	24

How To Setup Sensor Configuration	26
Sweep Frequency	26
Excitation Voltage	25
Temperature Unit	25
Display Resolution	25
Raw Data Unit	28
Engineering Unit Name	28
Calibration Factors	28
The DATA TO USB Menu	30
The DATE/TIME Menu	31
The CFG EXPORT Menu	32
The CFG IMPORT Menu	33
The INFO Menu	34
GUIDE TO THE CONFIGURATION FILE & DATA FILE	35
Content Of The Sensor Configuration File	35
Sweep Frequency	35
Excitation Voltage	35
Temperature Unit	35
Display Resolution	35
Raw Data Unit	35
Engineering Unit Name	35
Calibration Factors	35
Building a Sensor Configuration File	36
Building With VWnote Configuration Tool	36
Installing The VWnote Configuration Tool	36
Running The VWnote Configuration Tool	36
Finding And Interpreting Data Files	43
Locating Data Files	43
Interpreting The Data Files	45
Data Storage And Handling	45
MAINTENANCE GUIDE	46
Maintaining The VWnote	46
Battery Maintenance	46
Charging Unit LED Sequence	46
Calibration	47
Firmware And Software Updates	47
APPENDICES	48
Appendix A – How to Apply Calibration Factors for VW Sensors	48
Appendix B – Frequently Asked Questions	50

OVERVIEW & INTRODUCTION

Important information

The following symbols are used throughout the manual



IMPORTANT
INFORMATION



QUESTION



WARNING



TIP



! Important: Failure to adhere to the warnings in this manual may result in network disruption and possible data loss.

Failure to observe the warning may result in injury, product malfunction, unexpected readings or damage to the product that may invalidate its warranty.



Tips give additional information that may be helpful when using VWnote.

PRODUCT CHANGES

Soil Instruments has an on-going policy of design review and reserves the right to amend the design of their product and this instruction manual without notice.

WARRANTY

Refer to our terms and conditions of sale for warranty information. The batteries are a consumable item and are excluded from the warranty.

DISPOSAL

Products marked with the  symbol are subject to the following disposal rules in European countries:

- This product is designated for separate collection at an appropriate collection point
- Do not dispose of as household waste
- For more information, contact Soil Instruments or the local authority in charge of waste management

System Description

Things You Need to Know About VWnote

FEATURES

- Portable and rugged.
- Compatible with most commonly used VW sensors.
- Real-time display of VW sensor readings in engineering units as well as in Hz, Hz²/1000 and period.
- Fully configurable reading and displaying parameters of each sensor.
- Large data storage (2GB) and easy data retrieval via a USB flash drive.
- Firmware upgradable via USB flash drive by the user – no need for a PC and no need to return it back to factory.
- Powered by a Nickel Metal Hydride (NiMH) rechargeable battery, 30 hours without backlight and 15 hours with backlight. User selectable backlight for the display, auto shutdown after six minutes of inactivity.

BENEFITS

- Powerful features in a rugged and portable package; makes it easy to carry and operate in all site conditions.
- Easy to follow menu makes taking readings on site simple, fast and error free.
- The optional 15 VDC excitation, which provides higher energy excitation than the default excitation of 5 VDC, ensures quality readings for sensors with long cables.
- A site ID and a sensor name are assigned to each sensor. This facilitates management of a large quantity of VW sensors from a large site or multiple sites.
- Saved readings are grouped by dates which, together with the large internal memory, minimises data loss.
- Each reading is displayed and recorded with readings in raw and engineering units.
- The VWnote does not require a PC in the field to set up or download data, which means users of VWnote do not need to carry a site PC nor need to be computer literate to use VWnote.

System Components

THE VVNOTE

The VVnote is a handheld readout unit as well as a data logger for VW sensors. Below is a picture of the VVnote showing the various parts that you will use to interact with it.



USB FLASH DRIVE

Each VVnote will be supplied with a USB flash drive. Apart from being the distribution medium for the VVnote Configuration Tool software, you can also use it for data off-loading from the VVnote, as well as importing the configuration file to, and exporting it from, the VVnote.

VVNOTE CONFIGURATION TOOL SOFTWARE

Distributed on the USB flash drive with every VVnote is the VVnote Configuration Tool. This is a Windows-based software that you will use to create and edit the sensor configuration file, which will contain information on how readings from each sensor will be read, displayed and stored. See '*Guide To The Configuration File & Data File*' for more information.

VW SENSOR LEAD The VW sensor lead is shown in the picture below. One end of the lead has a Lemo plug that you will plug into the sensor connector on the top left of the VWnote. On the other end of the lead are four crocodile connectors coloured red, black, green and white, for connecting to the wires in the signal cable of a sensor with matching colours.



RECHARGEABLE BATTERY & CHARGER The VWnote contains a Nickel Metal Hydride (NiMH) rechargeable battery and is supplied with a trickle charge battery charger.



VWNOTE CARRY CASE The VWnote is supplied with a padded carry case with shoulder strap and pockets for the sensor connecting lead and the USB flash drive. We recommend that you carry and store the VWnote in the carry case whenever it is not being used.



Quick Start Guide

BEFORE YOU GO TO SITE:

1. Place the VWnote on charge, ensuring that you follow the charging procedure outlined in '*Detailed VWnote user Guide - Charging the VWnote*' is followed.
2. Switch on the VWnote.
3. Select '**DATE/TIME**' from the main menu to set the VWnote internal clock to the current date and time.
4. Select '**INFO**' to confirm that the firmware version is V2.01 or later. If the firmware needs updating, follow the instructions for firmware update in the '*Maintenance Guide - Firmware And Software Update*' section of this manual.
5. Test the reading function as follows:
 - Connect a VW sensor to the VWnote using the sensor lead
 - Go to '**READ**' in the main menu and select '**DEFAULT**' on the top of the site list and '**DEFAULT_VW**' from the top of the sensor list
 - Press ➡ to start reading
 - Check the VW reading and the temperature reading



Follow the troubleshooting guide in *Appendix B* of this manual if the readings are unstable or incorrect.

6. If you have a pre-prepared configuration file containing your custom sensor list, go to '**CFG IMPORT**' in the main menu to load the sensor list into the VWnote (for more details, see the '*Detailed VWnote user Guide*' section of this manual).
7. Switch off the VWnote by going to '**OFF**' in the main menu and pressing ➡.
8. Unplug the sensor lead from the VWnote. Replace the sensor connector cap and the USB port cap.
9. Place the VWnote in its carry case along with the sensor lead and a flash drive, ready to take to site.

WHEN YOU ARE IN THE FIELD:

1. Remove the VWnote from its carry case.
2. Switch on the VWnote, go to '**READ**' in the main menu and follow the procedures below to take a reading:
 - Connect a VW sensor to the VWnote using the sensor lead
 - Select your site from the site list and then your sensor from the sensor list

- If you do not have a pre-prepared sensor list, you can read the VW sensor by selecting 'DEFAULT_VW' from the sensor list, or you can add sites and sensors by going to 'SETUP' in the main menu (please refer to 'Detailed VWnote User Guide' for detailed instructions)
 - Press ➡ to start reading
 - If necessary, press ➡ again to view the reading quality indices. Press ← to return to the readings
 - Press 'Save' to send the current readings to the VWnote internal memory
 - Press ← once to return to the sensor list to select another sensor from the same site, or press ← twice to go to the site list to select another site
 - Disconnect the sensor cable from the crocodile clips
3. Repeat the procedures in Step 2 for any other sensors you wish to read, taking care to ensure that the sensor you are reading matches with the unique site and sensor ID in the VWnote.
 4. After you have finished taking readings for the current site, you can transfer the data straightaway to a flash drive in the field without the need for a site PC as follows:
 - Plug a USB flash drive into the USB port on the bottom of the VWnote
 - Go to 'DATA TO USB' in the main menu, and then press ➡ to display 'DO NOT ERASE INTERNAL DATA'
 - Press ↑ and ↓ arrows to select between 'DO NOT ERASE INTERNAL DATA' and 'ERASE INTERNAL DATA' before pressing 'Save' to initiate the transfer
 - The transfer is successful when the VWnote displays 'DATA SAVED TO USB'. Press ➡
 5. Before you move to the next sensor location or the next site, please ensure that you disconnect the sensor lead from the VWnote, replace all caps and return the VWnote back to its carry case for safe transport.

BACK IN THE OFFICE:

1. If you have not already downloaded the data to a flash drive (see Step 4 above), then do so now.
2. Transfer the data on the USB flash drive to a PC for further transfer or processing.

Please refer to the '*Detailed VWnote User Guide*' in this manual for more details of each step.

DETAILED VWNOTE USER GUIDE

Charging The VWnote

The VWnote is supplied with a Nickel Metal Hydride (NiMH) rechargeable battery. It is important to follow the charging procedure outlined below at all times to correctly maintain the battery.

STEP	ACTION
1	Make sure the VWnote is switched off
2	Remove the protective cap from the charging point, located on the top of the VWnote
3	Plug the connector into the charging point on the VWnote, making sure to align the connections correctly
4	Plug the charging unit into a mains power socket
5	Switch on the mains power to the charging unit
6	The LED on the charging unit will follow the sequence outlined in the table below
7	Place the protective cap back into the charging point on the VWnote when charging is complete

CHARGING UNIT LED SEQUENCE

STEP	LED	STATUS
1	Red - Green	Analysing battery status
2	Red - Green	
3	Red	Charging in progress
4	Green	VWnote charged; switched to trickle charge mode



Follow the charging procedure outlined in this manual at all times to properly maintain the battery. Do not overtighten the connector when charging the unit, to avoid damaging the socket.

Connecting Sensors to the VWnote

You can connect only one Vibrating Wire sensor at a time to the VWnote; this sensor can be with or without a built-in temperature sensor.

VW SENSOR WITH BUILT-IN TEMPERATURE SENSOR

All sensor connections to the VWnote are made via the Lemo plug which is located under a cap on the top of the VWnote; see figure below:



CLIP COLOUR	SENSOR TERMINAL
Red	VW +
Black	VW -
Green (or Blue)	Temperature +
White	Temperature -

Consult the sensor user manual for the sensor connections. If you are still unsure, please contact Soil Instruments.

Please ensure that the bare parts of the clips do not touch each other and cause shorts among the four wires.



VWnote is only compatible with the 3K ohm thermistor temperature sensors. It will not work with the RTD-based temperature sensor in some of the VW sensors.

VW SENSOR WITHOUT BUILT-IN TEMPERATURE SENSOR

For a VW sensor without built-in temperature sensor, only connect the sensor to the red and the black crocodile clips.



Only a qualified person trained in the use of VWnote and the VW sensors may connect sensors.

How to Use the Keypad

Below is a picture showing the keypad of the VWnote. Each key on the keypad has multiple functions depending on its context within the VWnote menu.



KEY	FUNCTION
On	The On button has two functions: <ol style="list-style-type: none">1. When the VWnote is off, pressing it turns the VWnote on.2. When the VWnote is already on, pressing it will toggle the LCD displays backlight between on and off.
Up (↑)	The ↑ key acts as an 'up' instruction in the situations below: <ol style="list-style-type: none">1. It moves the cursor up in the currently displayed list such as the main menu, list of sites, list of sensors, current readings, quality indices and various reading and display parameters.2. It increases the value of the current field when updating date/time.3. It moves upward through a list of alphanumeric letters when the site name, sensor name and sweep frequency are entered one character at a time.

KEY	FUNCTION
Down (↓)	<p>The ↓ key acts as a 'down' instruction in the situations below:</p> <ol style="list-style-type: none"> 1. It moves the cursor down in the currently displayed list such as the main menu, list of sites, list of sensors, current readings, quality indices and various reading and display parameters. 2. It decreases the value of the current field when updating date/time. 3. It moves downward through a list of alphanumeric letters when the site name, sensor name and sweep frequency are entered one character at a time.
Left (←)	<p>The ← acts as a back instruction or 'NO' to a question. When a menu option is selected or a question is displayed on the screen, pressing this key will take you back to the previous menu selection.</p>
Right (→)	<p>The → acts as a 'next' instruction in the situations below:</p> <ol style="list-style-type: none"> 1. When a menu option is displayed, pressing this key will take you to the next screen or stage of the menu functions. For example, when pressed while READ is selected, this key takes you to the list of sites; when a sensor is selected, this key will take you to the sensor reading screen. 2. When VWnote asks you to enter a site name, a sensor name, a frequency, this key will take you to the next character position. 3. When VWnote asks you to change date/time, this key will take you to the next field.
Save	<p>The Save button has several functions:</p> <ol style="list-style-type: none"> 1. When you set a new DATE/TIME for the VWnote, it commits the change to VWnote memory. 2. When you use SETUP to enter or edit reading, displaying and calibration parameters of a sensor in the sensor list, it commits the changes to VWnote memory. 3. When the sensor reading is displayed, it saves the latest reading. 4. It is also used as YES in response to the question 'ARE YOU SURE? YES(Save)/No(←)'. For example, when CFG EXPORT or CFG IMPORT is selected by pressing →, you will need to press Save to confirm that you want to proceed with the exporting or importing.

Menu Structure

MAIN MENU

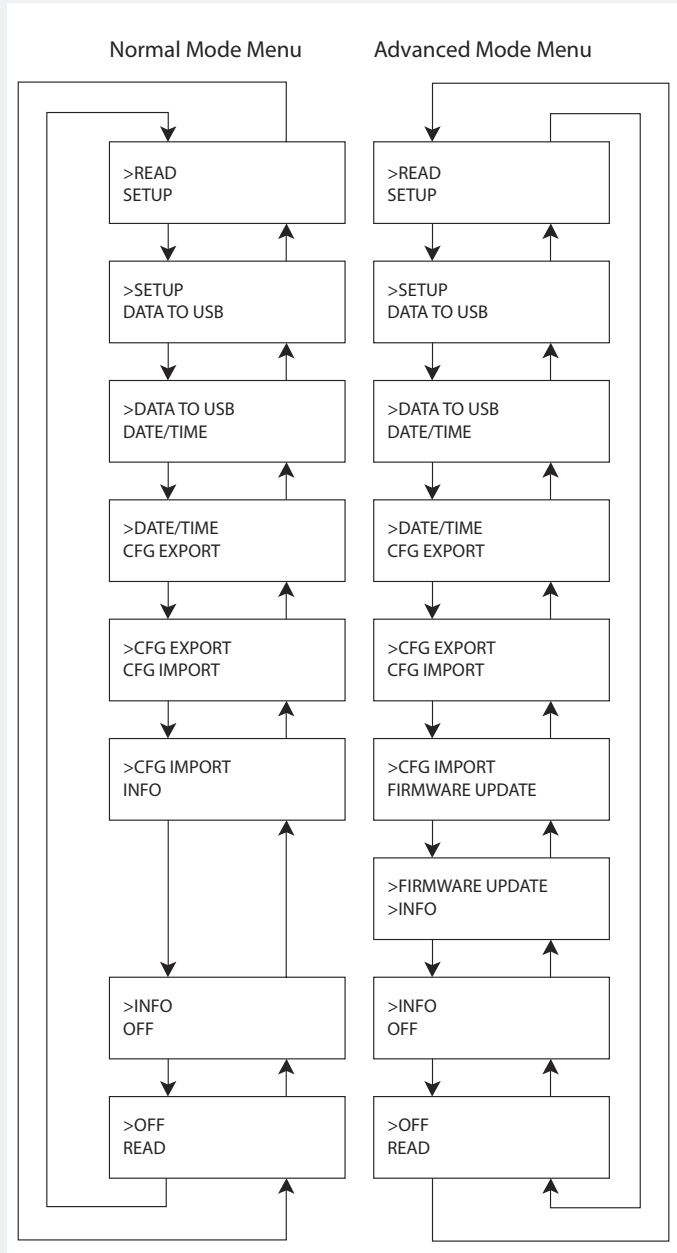

READ	Select this menu item to take a reading of the VW sensor that is currently connected to the VWnote.
SETUP	Select this item to add sensors to the list of sensors or to edit the reading and displaying parameters and calibration factors of an existing sensor.
DATA TO USB	Select this menu item to transfer data stored in the VWnote internal memory to the USB flash drive that is plugged into the VWnote USB port.
DATE/TIME	Select this menu item to display the date and time of the real-time clock in the VWnote and to update it when necessary.
CFG EXPORT	Select this option to copy the sensor list in the VWnote to the USB flash drive plugged into the VWnote USB port. If you add sensors or revised the sensor configuration in the VWnote using the keypad, you will need to make a copy of the new sensor configuration to the USB flash drive for backup or for further editing on your PC.
CFG IMPORT	This option is used to copy a new sensor configuration file from a USB flash drive to the VWnote, overwriting the existing sensor configuration in the VWnote.
FIRMWARE UPDATE	This option is only available in the Advanced Mode. You only need to perform a firmware update when instructed to do so by our support department. Instructions on how to access the Advanced Mode and how to perform firmware update will be provided.
INFO	<p>Choosing this option to display the following information about the VWnote:</p> <ul style="list-style-type: none"> • Serial number (S/N) of the VWnote • Version number and version date of firmware • Unit date and time • Battery Voltage • Storage (free) in % • Storage (used) in % <p>You can press the ↑ and ↓ arrows to scroll through the information.</p>
OFF	<p>To avoid accidental power down, the VWnote does not have an OFF button. You can switch off the VWnote by choosing 'OFF' in the menu and then pressing →. You will see a message saying 'POWER OFF. Bye! See you later!' before the unit switches off.</p> <p>As a power conservation measure, the VWnote will switch itself off automatically after six minutes of inactivity.</p>



You can navigate through the main menu by pressing **↑** and **↓**. The selected menu item is shown by a > in front of it.

The READ Menu

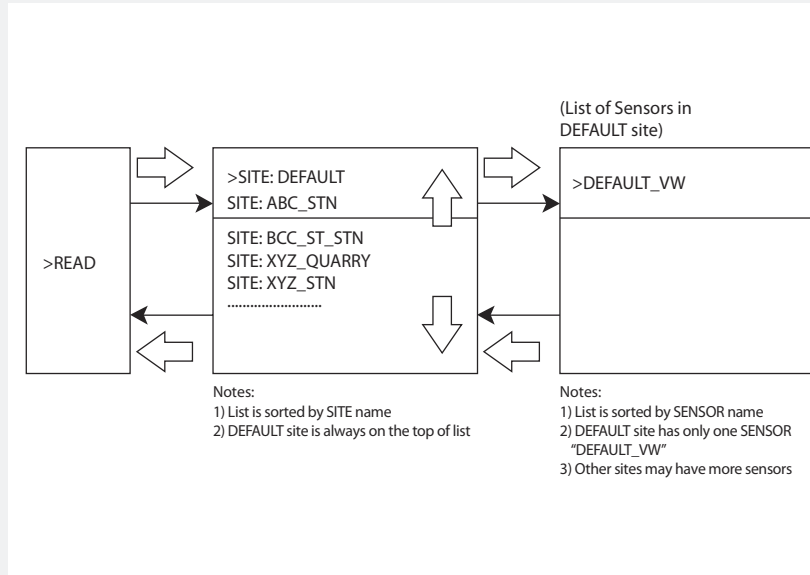

LIST OF SITES

1. The list of sites you specified will be displayed on the LCD screen, two sites per screen and sorted alphabetically. Use **↓** and **↑** to navigate up and down the list.
2. The top of the list is always **'DEFAULT'**, which is hard coded in the VWnote and cannot be changed by the user.

LIST OF SENSORS

1. The list of sensors you specified in the site you selected will be displayed on the LCD screen, two sensors per screen and sorted alphabetically. Use **↑** and **↓** to navigate up and down the list.
2. If you select the **'DEFAULT'** site, the top of the list is always **'DEFAULT_VW'**, which is hard coded in the VWnote and cannot be changed by the user.
3. The **'DEFAULT_VW'** is a generic sensor created in the VWnote for you to use to read VW sensors before you have the chance to set up a sensor list in the VWnote.

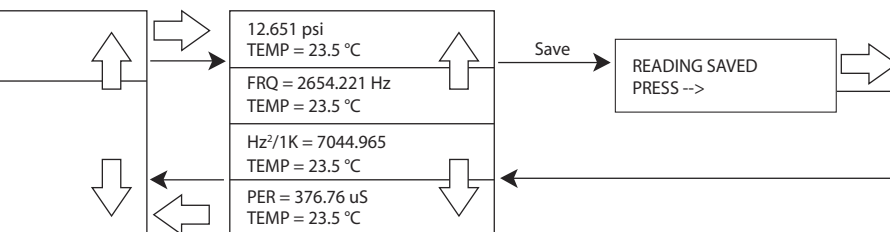

Notes:

- 1) VW readings displayed on four screens
- 2) First line of first screen is reading in engineering units
- 3) Other screens are readings in raw units



Sensor 'DEFAULT_VW' uses the following default parameters of reading and displaying:

- Site name: DEFAULT
- Sensor name: DEFAULT_VW
- Sweep frequency: 1400-3500 Hz
- Excitation V = 5V
- Display Resolution = 0.1
- Unit (raw) = Hz²/1K
- Unit (eng) = Hz²/1K
- R0=0
- G=-1
- Calibration=linear
- Unit (temp)=°C.

In most cases, the 'DEFAULT_VW' sensor will allow you to take readings from most type of VW sensors before you have the chance to define a sensor list for the VWnote.

SENSOR READING After you have selected which sensor to read by pressing ➔, the readings of the currently connected VW sensor will be displayed on four consecutive screens:

1. Screen 1 – The VW reading in engineering units (as calculated using the raw reading and the calibration factors and zero reading you specified) and temperature reading in °C (or °F).
2. Screen 2 – The VW reading in Hz and temperature reading in °C (or °F).
3. Screen 3 – The VW reading in Hz²/1000 and temperature reading in °C (or °F).
4. Screen 4 – The VW reading in period (μs) and temperature reading in °C (or °F).
5. You can navigate among the four screens by pressing ↑ and ↓. The readings will be automatically refreshed every two seconds.



Due to limited display space on the LCD screen, Hz²/1000 is displayed as Hz²/1K.



If no sensor is connected, or the sensor or signal cable is faulty, Screen 1 will display 'No VW sensor?' and/or 'No Therm. Sen.?' alerting you to the problem. In this case, you will not be able to navigate away from the first screen.

SAVE

1. Pressing the 'Save' key while you are on the sensor reading screen will send the current VW readings and temperature reading with time stamp to the VWnote internal memory. VWnote will display **'READING SAVED. PRESS ←'** to acknowledge the readings have been saved successfully.
2. Pressing ➔ will take you back to the sensor reading. From there you can save another set of readings for the same sensor, or you can press ← to return to the sensor list to select another sensor to read.

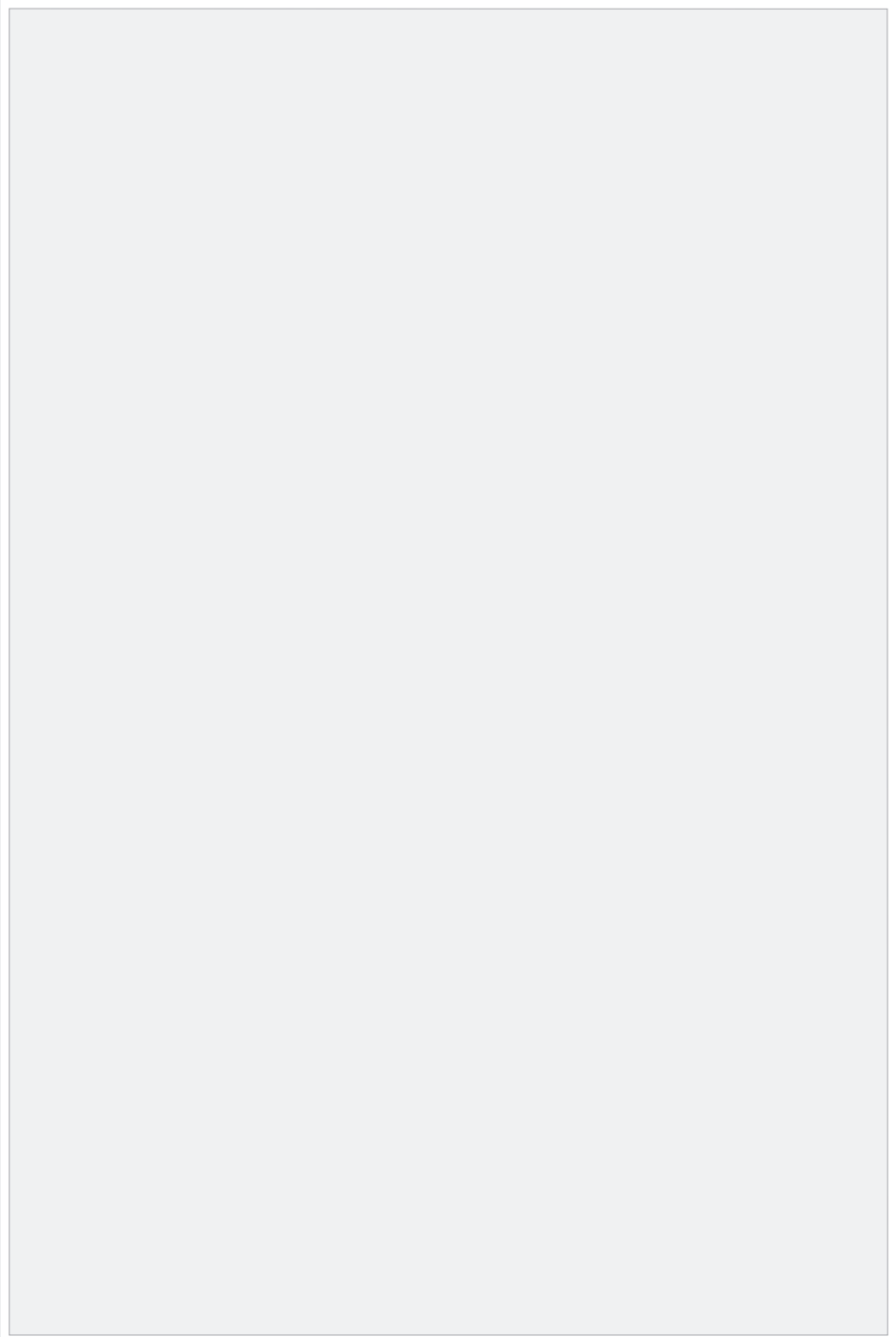







The SETUP Menu

SETUP

You can enter a new sensor configuration into VWnote or edit the existing sensor configuration in the VWnote using the keypad on the VWnote. The process is slow because there are only six keys on VWnote. It is designed for use on site when you need to add sensors or change the sensor configuration in an emergency. To set up sensor configuration in bulk, please use the VWnote Configuration Tool (more details are in '*Guide To The Configuration File & Data File*' section).

LIST OF SITES

1. The list of sites you specified will be displayed on the LCD screen, two sites per screen and sorted alphabetically. Use  and  to navigate up and down the list.
2. The top of the list is always '**ADD A SITE**'; when selected it will allow you to add a new site to the list of sites in the VWnote.
3. Press  to display a screen where you can enter a site name.
4. While you are on this screen, press  to go to the next character position, press  and  to go through the valid letters (A-Z, 0-9 and "_"). After you have entered the site name, press '**Save**' to enter the site name into VWnote.









The site name is limited to 10 characters and can contain only A-Z, 0-9 and "_".



Pressing  during entry or edit will not move the cursor one character to the left. It will cancel the entry or edit and take you back to the previous menu.

LIST OF SENSORS

1. The list of sensors in the site you selected will be displayed on the LCD screen, two sensors per screen and sorted alphabetically. Use  and  to navigate up and down the list.
2. The top of the list is always '**ADD A SENSOR**'; when selected it will allow you to add a new sensor to the list of sensors for the site you selected.
3. Press  to display a screen where you can enter a sensor name. After you have entered the sensor name, press **Save** to enter the site name into VWnote.
4. While you are on this screen, pressing  will move the cursor to the next character position; press  and  to go through the valid letters (A-Z, 0-9 and "_").



The sensor name is limited to 15 characters and can contain only A-Z, 0-9 and “_”.



Pressing ← during entry or edit will not move the cursor one character to the left. It will cancel the entry or edit and take you back to the previous menu.



The name of each sensor should be in the ‘Site + Sensor’ format. This will allow you to manage the sensors and their readings more efficiently by grouping them according to site names and with the sensors arranged in alphabetical order.

CONFIGURE A NEW SENSOR

After you add a new sensor VVnote will automatically assign the following default values to the reading and displaying parameters listed below:

- Sweep frequency = 1400-3500Hz
- Excitation V = 5V
- Unit (temp) = °C
- Display Resolution = 0.1
- Unit (raw) = Hz²/1000
- Unit (eng) = blank
- Calibration = linear
- R0 = 0
- G = -1.

More detailed descriptions on these parameters are given in the next section. By pressing → once, you can view and revise the values of the above sensor parameters.

CONFIGURE AN EXISTING SENSOR

After you have selected an existing sensor from the sensor list from the selected site, press → once to view and revise the value of the sensor configuration parameters stored in the VVnote.

FLOW DIAGRAM

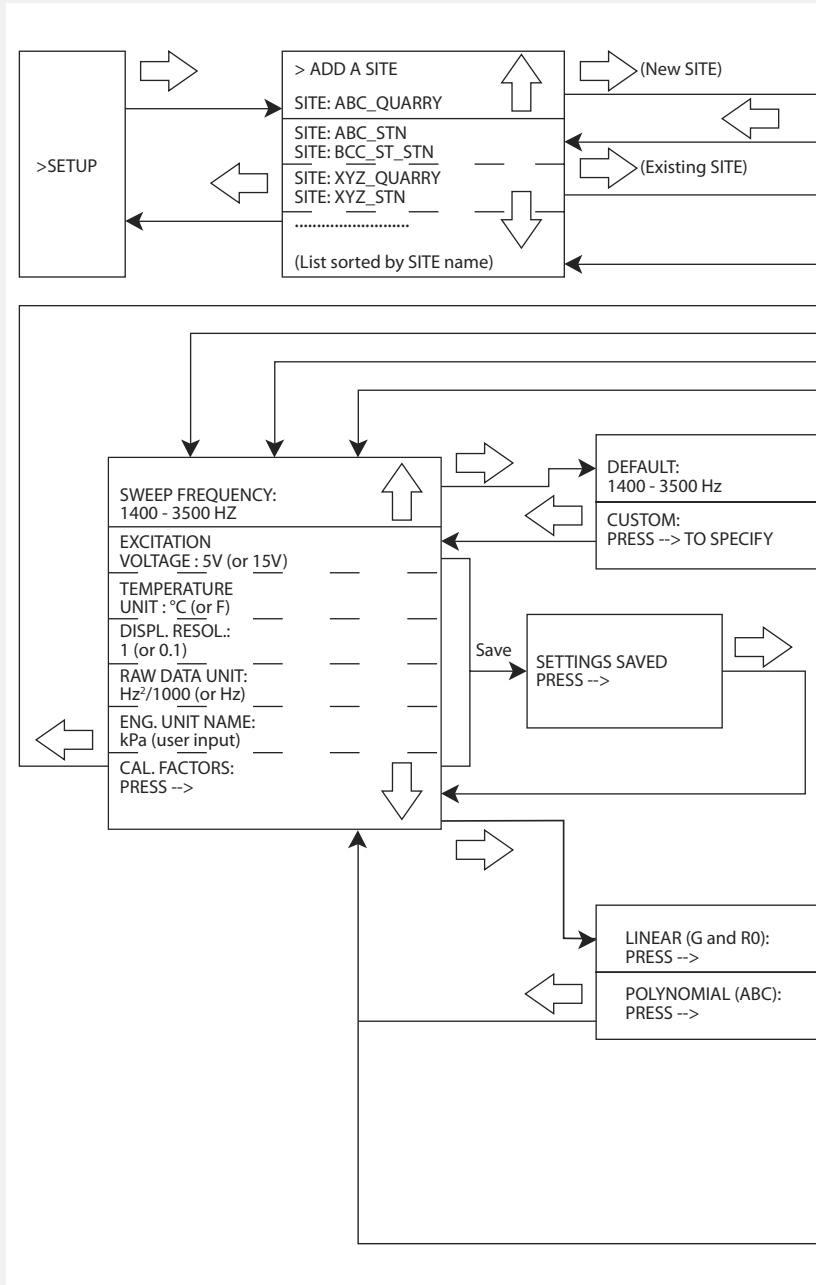

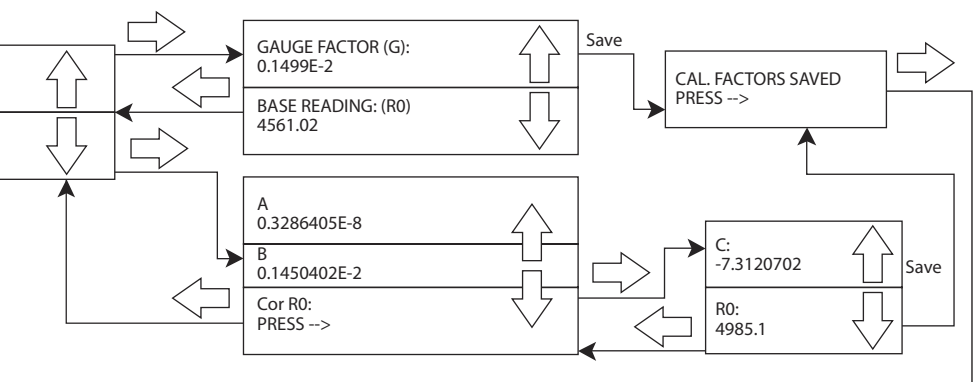
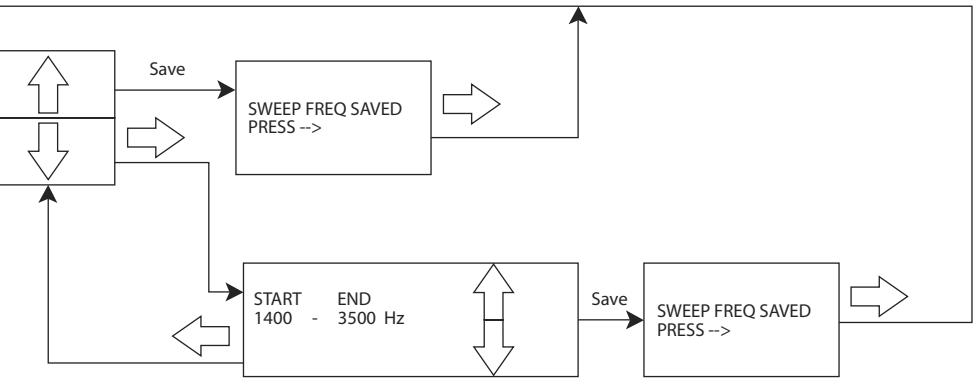
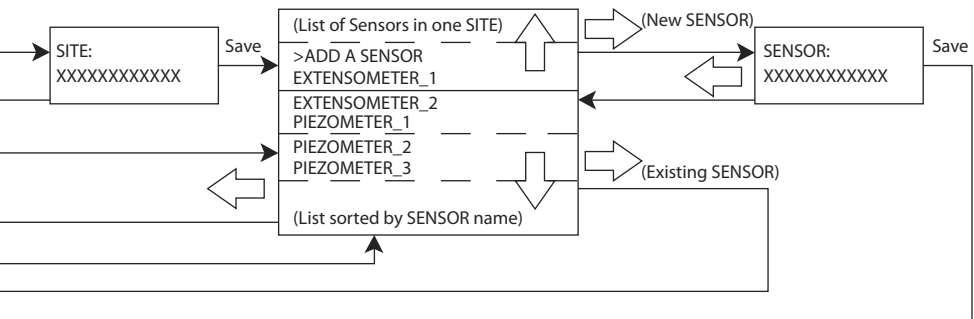

How to Set Up Sensor Configuration

The following eight parameters define how each sensor is read and how the readings are displayed. The current settings for these parameters are presented on eight screens that you can scroll through using \uparrow and \downarrow . Pressing \rightarrow while each parameter is displayed will take you to further screens where you can edit their values.

1. SWEEP FREQUENCY:

- At the top of the list of sensor configuration parameters is the range of sweep frequency currently used by VWnote to read this sensor.
- Press \rightarrow to open up another screen to select the default range or to define a custom range (using \uparrow and \downarrow).
- If you select the custom range and press \rightarrow you will be presented with another screen where you can enter the start and end frequencies.
- When entering a sweep frequency, use \rightarrow to move the cursor to the next character position and use \uparrow and \downarrow to move through 0-9. Press the Save key to confirm the edit, or \leftarrow to cancel the change and return back to the previous screen.



Pressing \leftarrow during entry or edit will not move the cursor one character to the left. It will cancel the entry or edit and take you to the previous menu.



These are our recommended sweep ranges for the VWnote:
450 Hz - 1125 Hz,
800 Hz - 2000 Hz,
1700 Hz - 3500 Hz,
2300 Hz - 6000 Hz.



VWnote will issue error messages if you enter a frequency that is less than 450 Hz, greater than 6000 Hz, or if the end frequency is less than the start frequency.

2. EXCITATION VOLTAGE:

- The default excitation voltage that VWnote uses to energise the sensor before taking a reading is 5 V. This is sufficient for most site conditions where the sensors have a short cable length
- You can select the optional 15 V excitation if the sensor has a long cable
- Press **➔** to toggle between 5 V and 15 V. Press 'Save' to commit the change to VWnote or **⬅** to cancel.



The maximum cable length that 5 V excitation will work is dependent on factors such as the gauge size of the wires. However, as a rule of thumb, cable lengths greater than 200m (600ft) are usually considered to be long.

3. TEMPERATURE UNIT:

- The default temperature unit that VWnote uses to display the sensors built-in temperature sensor is °C
- You can select the optional °F
- Press **➔** to toggle between C and F. Press 'Save' to commit the change to VWnote or **⬅** to cancel the change you have just made.

4. DISPLAY RESOLUTION (DISPL. RESOL.):

- The display resolution for each sensor reading (in raw or engineering units) can be set to match your needs.
- The default value for this parameter is 0.1 (1 digit after the decimal point).
- You can select from 1, 0.1 (equivalent to 0 & 1 digit after decimal point).
- Press **➔** until the one you wish to use is displayed for this sensor. Press Save to commit the change to VWnote or **⬅** to cancel the change you have just made.

5. RAW DATA UNIT:

- Although three raw data formats (Hz, Hz²/1000 and period) are displayed by VWnote while the sensor is read, only one raw reading (in Hz or Hz²/1000) is saved and used for conversion into reading in engineering units
- The default value for this parameter is Hz²/1000
- Press → to toggle between Hz²/1000 and Hz
- Press Save to commit your selection to VWnote or ← to cancel the change you have just made.



You can find the raw data unit on the calibration sheet of the VW sensor.

6. ENGINEERING UNIT NAME (ENG. UNIT NAME):

- This is the name of the engineering unit that you would like to use when the reading of this sensor is displayed and saved, such as kPa, psi and mH₂O
- It is a text string with up to eight characters. Except “(comma)”, all other alphanumeric characters and symbols (such as +, -, %, &, etc) are allowed.
- The default value for this parameter is ‘blank’
- When entering an engineering unit name, use → to move the cursor to the next character position and use ↑ and ↓ to move through allowed characters
- Press ‘Save’ to commit your entry to VWnote or ← to cancel the change you have just made.



Pressing ← during entry or edit will not move the cursor one character to the left. It will cancel the entry or edit and take you to the previous menu.

7. CALIBRATION FACTORS (CAL FACTORS):

- Calibration factors are used to convert sensor raw readings (defined above) into values in engineering units (also defined above)
- The default calibration is linear which requires a gauge factor (G) and a base reading (R0)
- Press → to go to the screen where you can select between ‘LINEAR (G and R0)’ and ‘POLYNOMIAL (ABC)’
- If you select ‘LINEAR’, pressing → will take you to the two screens where you can review, enter or edit G and R0

- If you select POLYNOMIAL:
 1. Pressing \rightarrow will take you to the next screen where you can view, enter or edit the value of A.
 2. Pressing up and down will display other screens displaying value of B and 'R0 or C? PRESS \rightarrow '.
 3. Pressing \rightarrow when 'R0 or C?' is displayed will take you to two further screens for R0 and C.
 4. Use \uparrow and \downarrow to select which option you want. The last one you view before you press 'Save' will be used in the calculation from raw reading to engineering unit.
- When entering a numeric value, use \rightarrow to move the cursor to the next character position and use \uparrow and \downarrow to move through 0-9 and '-' and 'E', where 'E' is for entering numeric values with exponent, for example 1.234E-8 for 1.234×10^{-8} .
- When you are making an edit, press 'Save' to commit your entry to VWnote or \leftarrow to cancel the change you have just made.



Pressing \leftarrow during entry or edit will not move the cursor one character to the left. It will cancel the entry or edit and take you to the previous menu.



The value for R0 is in raw data units, such as Hz or Hz²/1000. More information on sensor calibration factors is given later in *Appendix A*.

The DATA TO USB Menu

You don't need a site PC to download saved data from the VWnote. Instead, you transfer the saved data to a USB flash drive then transfer the data to a PC, which need not be in the same office or the same site as the VWnote.

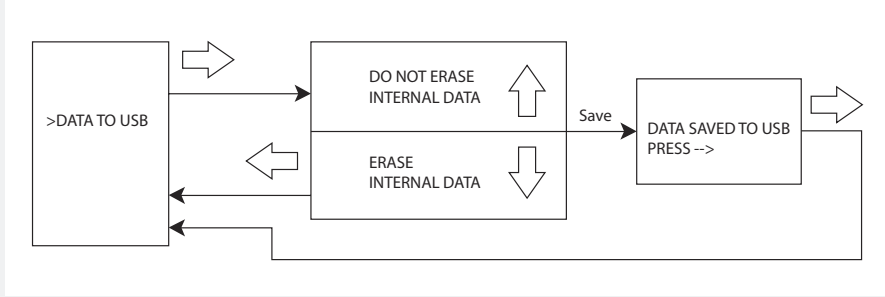

STEP	ACTION
1	Insert the USB flash drive into the USB slot on the bottom of the VWnote.
2	On the VWnote, navigate through the menu to ' DATA TO USB ' and press →.
3	You then have two options ' DO NOT ERASE INTERNAL DATA ' or ' ERASE INTERNAL DATA '; scroll between the two options using ↑ and ↓, choose your option and press the ' Save ' button.
4	Note: choosing ' ERASE INTERNAL DATA ' will erase the data after the transfer to the USB; choosing ' DO NOT ERASE INTERNAL DATA ' will keep whatever data is in the VWnote internal memory intact.
5	The screen will say ' DATA SAVED TO USB. PRESS → '. Pressing → will take you back to the menu.
6	Remove the USB flash drive from the VWnote, remembering to replace the protective cap on the USB port. The data is now on the USB.

The format of the data files will be discussed in more detail in '*Guide To The Configuration File & Data File*'.

The DATE /TIME Menu

Select this menu item to update the date and time of the VVnote internal clock. The date is in ISO format (YYYY-MM-DD). Use → to move the cursor from the field of year to fields of month, day, hour, minute, second and back to year, and so on. While in each field, use ↑ and ↓ to increase or decrease the value of that field. Press 'Save' to commit the changes to VVnote internal clock. This menu only needs to be executed occasionally.

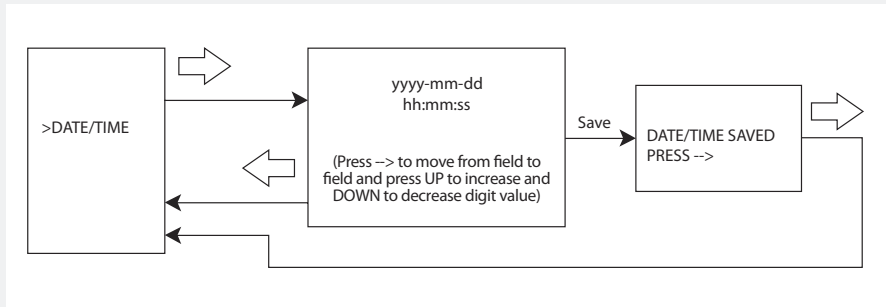

The CFG EXPORT Menu

If you have added new sensors to the VWnote or made changes to the sensor configuration in the VWnote using the keypad, you can back up the sensor configuration to a flash drive using this menu item.

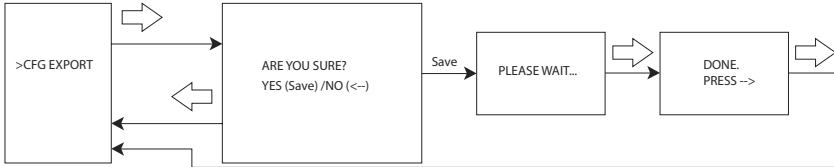

STEP	ACTION
1	Ensure the VWnote is switched on.
2	Insert the USB flash drive into the USB port on the base of VWnote.
3	Press ↑ and ↓ to scroll through the main menu until you find 'CFG EXPORT'.
4	Select this option using the → , you will see a message saying 'ARE YOU SURE? YES (Save)/NO (←)'
5	Press 'Save' to proceed or ← to cancel and return to the previous screen.



The sensor configuration in the VWnote will be saved in the root folder on the USB flash drive with the file name '**VW_CONF0.vwn**'. It will overwrite any file with the same name in the root folder.

The CFG IMPORT Menu

In addition to entering sensor configuration using the keypad, you can produce a sensor configuration file on your PC using the VWnote Configuration Tool software. For the import to work, the configuration file must be named as 'VW_CONF0.vwn' and reside in the root folder on the USB flash drive.

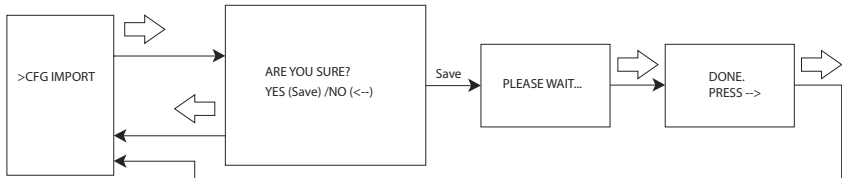

STEP	ACTION
1	Ensure the VWnote is switched on.
2	Insert the USB flash drive into the USB port on the base of VWnote.
3	Press ↑ and ↓ to scroll through the main menu until you find 'CFG IMPORT'.
4	Select this option using the → , you will see a message saying 'ARE YOU SURE? YES (Save)/NO (<-)'. Save
5	Press 'Save' to proceed or ← to cancel and return to the previous screen.



The sensor configuration in the VWnote will be overwritten by that in the configuration file.

The INFO Menu

This menu item allows you to view information about the VWnote. The information includes:

- VWnote serial number
- Firmware version number and compilation date of firmware
- Data and time of the VWnote's internal clock
- Storage capacity in MB (used)
- Storage capacity in MB (free).

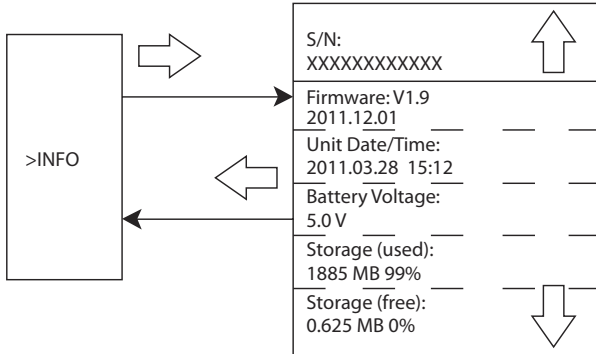

GUIDE TO THE CONFIGURATION FILE & DATA FILE

Content of the Sensor Configuration File

The Sensor Configuration File contains the following eight parameters that define how each sensor is read and how the readings are displayed.

**1. SWEEP
FREQUENCY:**

You need to set the sweep frequency to any range between 450 Hz and 6000 Hz, such as 450-1250 Hz or 1200-2800 Hz.

**2. EXCITATION
VOLTAGE:**

The default excitation voltage that VWnote uses to energise the sensor before taking a reading is 5 VDC. This is sufficient for most site conditions where the sensors have a short to medium cable length. You can select the optional 15 VDC excitation if the sensor has a long cable. The maximum cable length that 5 VDC excitation will work is dependent on factors such as the gauge size of the wires. However, as a rule of thumb, cable lengths greater than 200m (600ft) are usually considered to be long.

**3. TEMPERATURE
UNIT:**

By default, temperature readings will be displayed as °C. Optionally, you can select °F

**4. DISPLAY
RESOLUTION:**

The display resolution for each sensor reading (in raw or engineering units) can be set to match your needs. The default value for this parameter is 0.1 (1 digit after the decimal point). You can select from 1 & 0.1 (equivalent to 0 & 1 digit after decimal point).

**5. RAW DATA
UNIT:**

This defines the raw reading (in Hz or Hz²/1000) that is saved and used for conversion into reading in engineering units. The default value for this parameter is Hz²/1000.

**6. ENGINEERING
UNIT NAME:**

This is the name of the engineering unit that you would like to use when the reading of this sensor is displayed and saved, such as kPa, psi and mH₂O. It is a text string with up to 8 characters. The default value for this parameter is "blank".

**7. CALIBRATION
FACTORS:**

Calibration factors are used to convert sensor raw readings (defined above) into values in engineering units (also defined above). The default calibration is linear which requires a gauge factor (G) and a base reading (R0). If you select polynomial you will need to enter A, B and R0 or C, where the value for R0 is in raw data units, such as Hz or Hz²/1000.

Please see **Appendix A** of this manual for a more detailed description of the calibration factors.

Building a Sensor Configuration File

You can build the list of sensors with configuration in two ways:

- Using the keypad on the VWnote to create and edit the list in the VWnote's internal memory. See '*Detailed VWnote User Guide*'
- Using the VWnote Configuration Tool software (supplied free of charge) to create and maintain the Sensor Configuration File on your PC, then transfer it to the VWnote's internal memory using a USB flash drive.

BUILDING WITH VWNOTE CONFIGURATION TOOL

VWnote Configuration Tool is a piece of Windows PC-based software written to create and maintain the sensor configuration files. It is supplied free with the VWnote. You can also download a copy of the latest version from www.soilsupport.co.uk.

INSTALLING THE VWNOTE CONFIGURATION TOOL

The latest version of VWnote Configuration Tool is distributed free on the USB flash drive delivered with each VWnote. It is a single exe file named '**VWnote Configuration Tool .exe**' residing in the VWnote software folder on the USB flash drive. There is no need to run a set up program to install it.



VWnote Configuration Tool requires '**Microsoft .NET Framework 3.5**' to run. On modern PCs running '**Windows 7**' or above, '**.NET Framework**' is already installed. Download a copy from Microsoft.com if you are running an older operating system, such as '**Windows XP**', and do not have it on your PC yet.

RUNNING THE VWNOTE CONFIGURATION TOOL

You will need the following items before running the Tool:

- A Windows PC with the following minimum PC requirements
- A USB flash drive with the VWnote Configuration Tool software.

The PC running the VWnote software must have the following minimum requirements:

- '**Windows XP**' and above operating system
- Pentium 4, 1 GHz or better specification
- 1 GB RAM
- 40 GB hard drive or solid state drive
- USB port interface.

You can run the Tool directly on the USB flash drive or you can copy it on to the hard drive on your PC and run it from there.

STEP**ACTION**

1 Insert the VVnote USB flash drive into the PC.

2 Open the VVnote software folder on the flash drive and run **VVnote Configuration Tool.exe**.

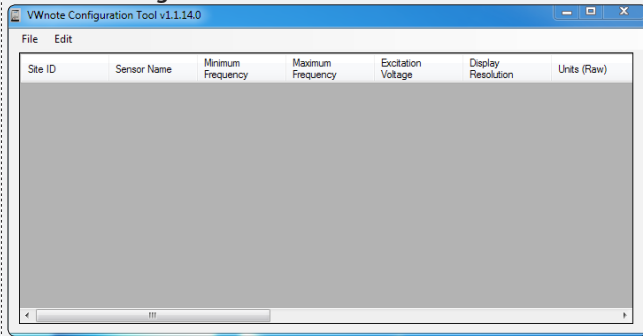

3 Click on **'File'** then **'New'** to create a new configuration file.

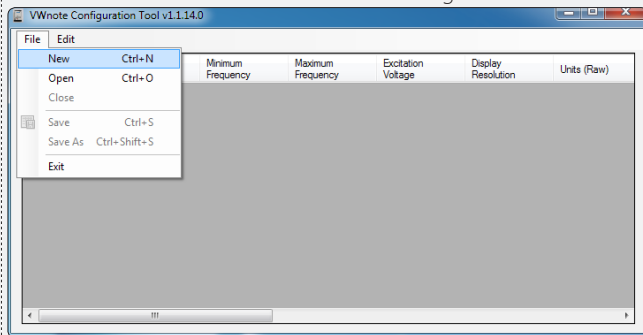

4 After you elect to create a new configuration file, the **'Add New Sensor'** window will be displayed to allow you to add a new sensor to the configuration file.

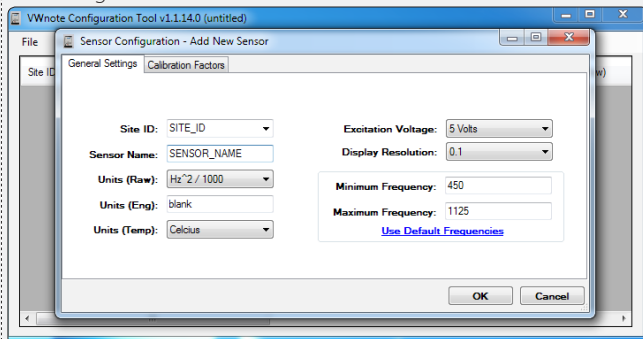

STEP**ACTION**

5

Click on either the 'General Settings' or 'Calibration Factors' tab on the Sensor Configuration Window.

Clicking on the **Cancel** button will cancel the addition of a new Sensor Configuration.

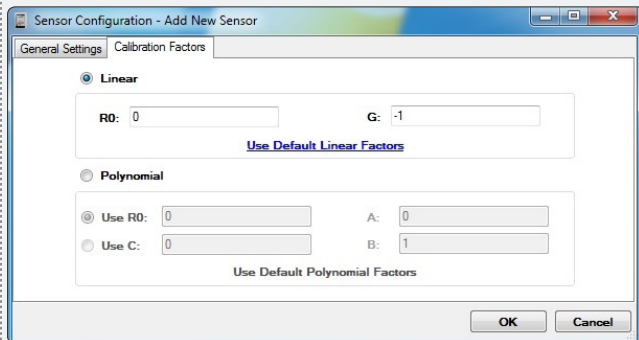
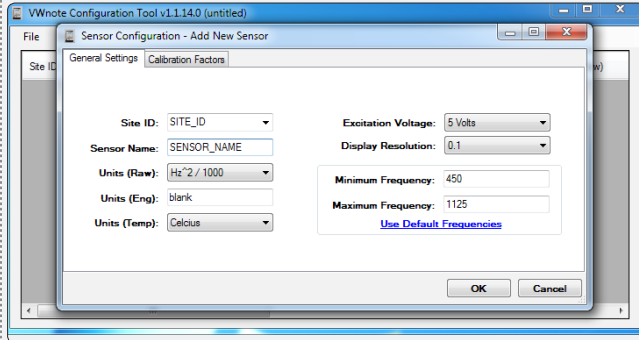

6

Hovering over an input field with the mouse will bring up a short description of that field.

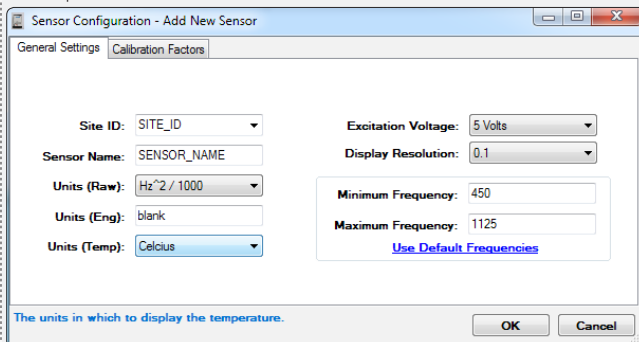

STEP**ACTION**

7

When you have finished filling in the details, click **'OK'** to continue. If there is an error in any field, it will be highlighted in red – mouse over the highlighted field to show the error message on the bottom left of the window.

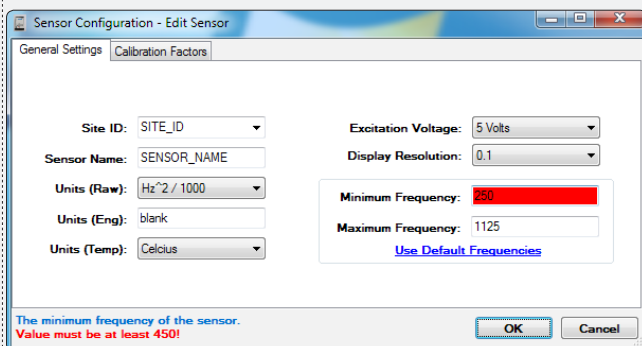

8

If there was no error, the **'Sensor Configuration'** Window will close and you will see the new **'Sensor Configuration'** in the data table on the main **'Configuration Tool Window'**.

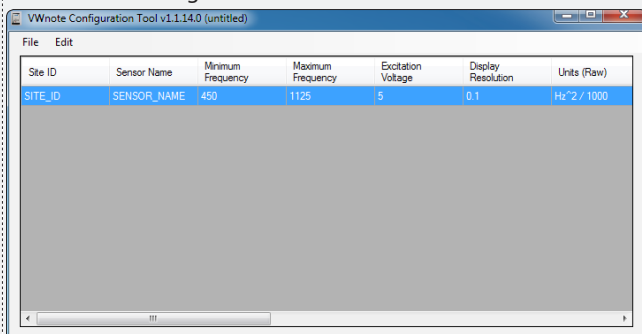

9

To add another Sensor Configuration, go back to step 4.

STEP**ACTION**

10

To edit an existing Sensor Configuration, select the configuration you want to edit and go to **'Edit'** then **'Edit Sensor'**.

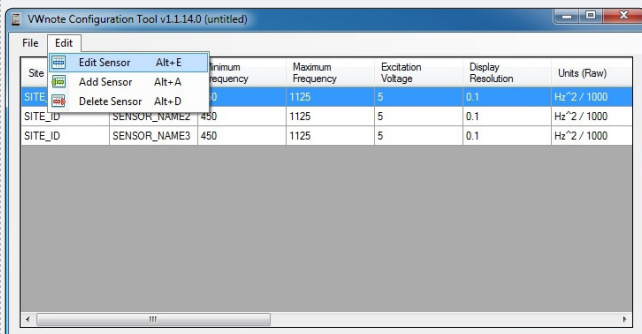

11

This will bring up the **'Sensor Configuration'** window, with the details for the selected configuration. Clicking on the **'Cancel'** button will cancel any changes to the selected **'Sensor Configuration'**.

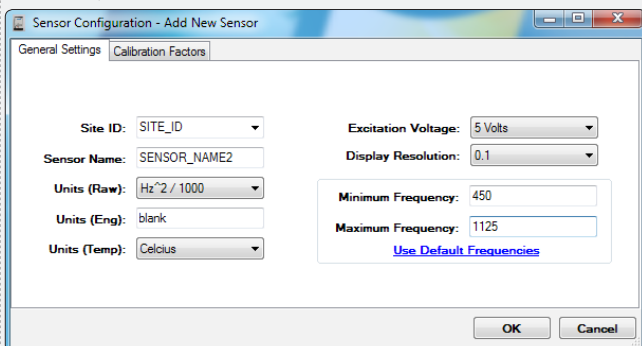

12

Click the **'OK'** button to save the changes. You will be returned to the main **'Configuration Tool'** Window.

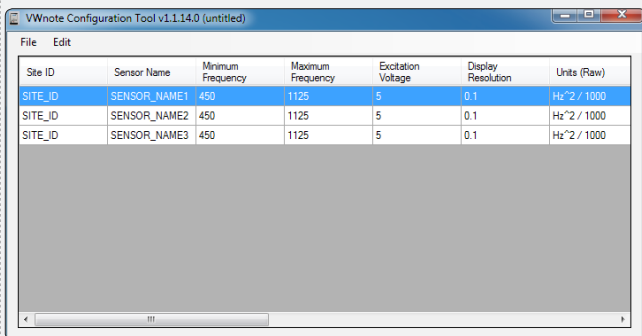

STEP**ACTION**

13

To delete a 'Sensor Configuration', select the configuration you want to delete and click on **Edit** then **Delete Sensor**. This will remove the Sensor Configuration from the list.

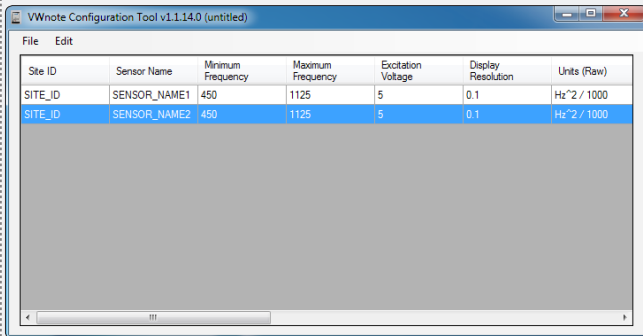
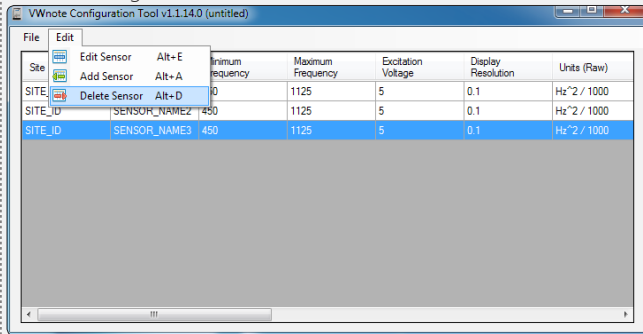

14

To save the 'Sensor Configurations', go to **File** then **Save!** If you created a new file, the 'Save File Dialogue' will display. Type in a name for the file or accept the recommended name and click **Save!**

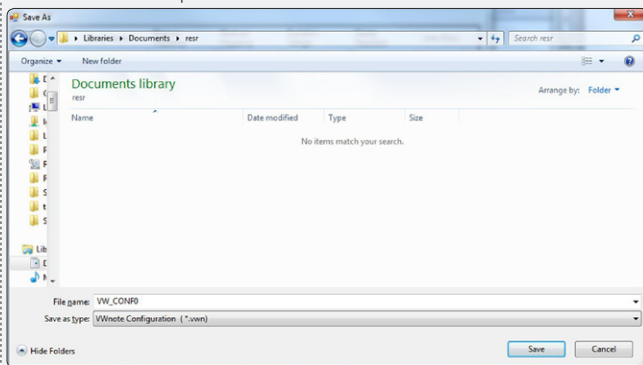

STEP**ACTION**

15

If you edited an existing file, **'File'- 'Save'** will save it over the existing configuration file without asking.

16

When you are asked to enter or confirm a file name, a warning message will appear alerting that VWnote will only recognise **'VW_CONF0.vwn'** while performing **'CFG IMPORT'**.

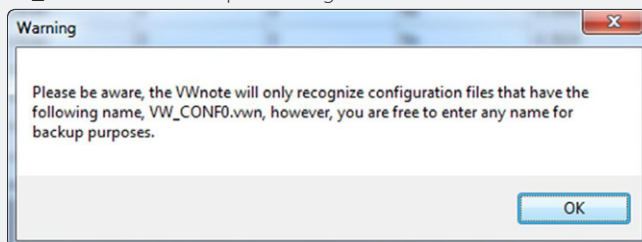

17

To exit the program, click on **'File'** then **'Exit'**, or click the red **'X'** in the upper right corner of the window.

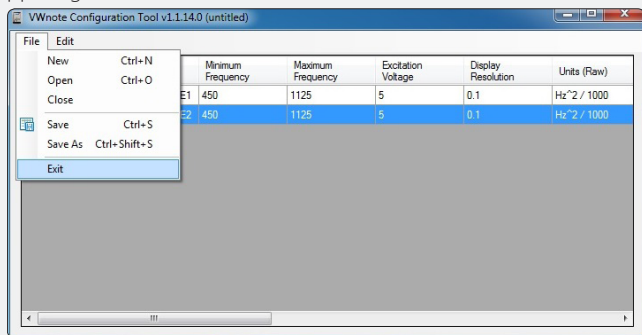

Finding And Interpreting Data Files

LOCATING DATA FILES

The data collected from a VWnote is stored internally and retrieved using a USB flash drive.

When you open the flash drive folder on a PC or laptop, you will find a folder has been created with the name made up of the prefix 'VN' and the download date in the format YYMMDD, for example 'VN130321' shows the data downloaded on 21 March 2013.

Double-click on the folder to open it and you will see one or more Excel-compatible '**CSV files**'. Each file is named by the date of the readings taken in the format YYYYMMDD; for example, '20130321.csv' is a file of the readings taken on 21 March 2013. Only one file per day is created.

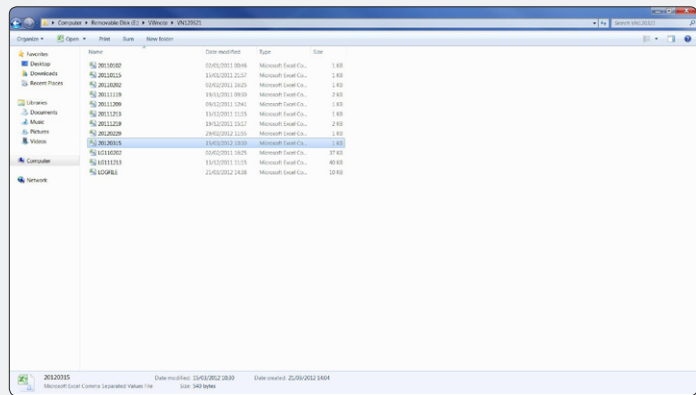

If you downloaded the data when older readings had not been erased from the internal memory on the previous download, each set of readings will be shown in an Excel-compatible '**CSV file**'. However, if you downloaded data after all internal data had been erased during a previous download, then there should only be one reading file plus a Logfile (LOGFILE.CSV).

The Logfile is simply a record of events such as powering on or low battery, with a note of the battery voltage; this is for diagnostic purposes only and you may ignore it.

Time	Event	Battery Voltage (V)
01/01/2011 01:00:00	Power on	2.5
01/01/2011 00:00:00	Battery low	2.5
01/01/2011 00:00:00	Power on	6.3
01/01/2011 00:00:00	Power on	6.3
15/12/2011 11:56	Power off	6.3
08/12/2011 11:35	Power on	6.3
08/12/2011 11:41	Power on	6.3
08/12/2011 11:42	Power on	6.3
08/12/2011 11:46	Power on	6.3
08/12/2011 11:48	Power on	6.3
10/12/2011 10:44	Power on	6.3
10/12/2011 10:47	Power on	6.2
10/12/2011 10:47	Power on	6.2
10/12/2011 10:43	Power on	6.2
10/12/2011 10:43	Power on	6.2
14/12/2011 09:50	Power on	6.2
14/12/2011 09:00	Power on	6.2
14/12/2011 09:05	Power on	6.2
14/12/2011 10:07	Power on	6.2
14/12/2011 10:08	Power on	6.2
14/12/2011 10:09	Power on	6.2
14/12/2011 10:10	Power on	6.2
14/12/2011 10:10	Power on	6.2
14/12/2011 10:10	Power on	6.2
14/12/2011 10:10	Power on	6.2
14/12/2011 10:13	Power on	6.2
14/12/2011 10:13	Power on	6.2
14/12/2011 10:13	Power on	6.2

Click on a readings file to open it (further explanation of the data shown is given in the next subsection).

Time	Sensor ID	Sensor Name	Unit	Value	Unit	Value	Unit	Value	Unit
17/04/2012 09:06	DEFAULT	VW	5823.43	hp/2/1K	23	C	400	6000	
17/04/2012 09:06	DEFAULT	VW	5823.43	hp/2/1K	23	C	400	6000	
17/04/2012 09:05	A	W	5823.43	hp/2/1K	23	C	400	6000	
17/04/2012 09:06	W	W	5823.43	hp/2/1K	23	C	400	6000	
17/04/2012 11:03	A	W	5826.27	hp/2/1K	24	C	400	6000	
17/04/2012 11:03	A	W	5826.27	hp/2/1K	24	C	400	6000	
17/04/2012 11:04	A	W	5826.53	hp/2/1K	24	C	400	6000	
17/04/2012 11:04	A	W	5826.54	hp/2/1K	24	C	400	6000	
17/04/2012 17:30	DEFAULT	VW	5813.02	hp/2/1K	24	C	400	6000	
17/04/2012 17:30	DEFAULT	VW	5813.04	hp/2/1K	24	C	400	6000	
17/04/2012 17:41	DEFAULT	VW	5813.89	hp/2/1K	24	C	400	6000	
17/04/2012 17:41	DEFAULT	VW	5813.87	hp/2/1K	24	C	400	6000	

INTERPRETING THE DATA FILE

The data file is in 'comma separated value' (CSV). The field delimiter symbol is the "," (comma) character. The record delimiter string in the CSV file is 'CR+LF' characters (carriage return and line feed).

There is a header line appearing as the first line of the file with the same format as normal record lines. This header contains names corresponding to the fields in the file and contains the same number of fields as the records in the rest of the file.

The table below shows the fields in the data file for each line.

COLUMN	FIELD NAME	FORMAT
1	Date/Time	yyyy-mm-dd hh:mm:ss
2	Site name	Text, 10 chrs, A-Z, 0-9, _
3	Sensor name	Text, 15 chrs, A-Z, 0-9, _
4	VW raw reading	Number, floating point
5	VW raw reading unit name	Hz or Hz ² /1000
6	VW reading in engineering unit	Number, floating point
7	Engineering unit name	Text, 8 chrs
8	Temperature reading	Number, floating point
9	Temperature	°C or °F
10	Start sweep frequency	Number, integer
11	End sweep frequency	Number, integer
12	VWnote internal temp. in °C	Number, floating point
13	VWnote battery voltage	Number, floating point

DATA STORAGE AND HANDLING

The standard internal memory capacity of the VWnote is 2GB, which is sufficient to store over 6 million sets of readings and the configuration parameters of several thousands of sensors.

It is possible to increase the memory size but research at Soil Instruments has shown that 2GB is more than ample storage.

MAINTENANCE GUIDE

Maintaining The VWnote

The VWnote is manufactured with a multi-layer circuit board containing surface mount components. For this reason there are no parts which require routine maintenance.

BATTERY MAINTENANCE

The VWnote is supplied with a Nickel Metal Hydride (NiMH) rechargeable battery. Although the battery requires no maintenance as such, it is important to follow the charging procedure outlined below at all times to correctly maintain the battery.

As rechargeable batteries decay over time, the VWnote battery will be tested and replaced if necessary, during annual re-calibration.

STEP	ACTION
1	Make sure the VWnote is switched off
2	Remove the protective cap from the charging point, located on the top of the VWnote
3	Plug the connector into the charging point on the VWnote, making sure to align the connections correctly
4	Plug the charging unit into a mains power socket
5	Switch on the mains power to the charging unit
6	The LED on the charging unit will follow the sequence outlined in the table below
7	Place the protective cap back into the charging point on the VWnote when charging is complete

CHARGING UNIT LED SEQUENCE

STEP	LED	STATUS
1	Red - Green	Analysing battery status
2	Red - Green	
3	Red	Charging in progress
4	Green	VWnote charged; switched to trickle charge mode



Follow the charging procedure outlined in this manual at all times to properly maintain the battery.

Battery life: Battery life is a function of a combination of the following factors;

- Battery type
- Sensor type
- How often the VWnote is used to take reading
- How often the data are offloaded
- How often the backlight is switched on
- Ambient temperature.

In designing the VWnote system, Soil Instruments have produced firmware routines to maximise the battery life. As a rule of thumb, the VWnote can achieve battery life of up to 30 hours without backlight and 15 hours with the backlight switched on.

To maximise battery life, the VWnote has an inbuilt off timer. When the VWnote has been inactive for six minutes it will automatically turn off.

Battery voltage: The VWnote saves its battery voltage with every reading to enable batteries to be monitored and recharged in a timely manner. The battery voltage in the VWnote should be above 5.0 volts for the VWnote reading circuitry to work. If the voltage goes below 3.6 volts, the VWnote will shut off.

CALIBRATION

Each VWnote is calibrated before it is shipped. To meet your calibration needs, we offer re-calibration services at our facilities. If you intend shipping the VWnote back to our factory, please contact Soil Instruments or our distributors for more information.

FIRMWARE AND SOFTWARE UPDATE

From time to time, Soil Instruments may issue updates to the firmware and the VWnote Configuration Tool for additional features or bug fixes. Details of how to update these will be provided as the situation arises.

APPENDICES

Appendix A – How to apply Calibration Factors for VW Sensors

The calibration certificate for your VW sensor will provide you with the information on how to convert the raw readings into readings in engineering units.

Below is an example of calibration certificate from Soil Instruments:



Bell Lane, Uckfield, East Sussex
 TN22 1QL United Kingdom t: +44 (0) 1825 765044 e: info@soilinstruments.com w: www.soilinstruments.com
 Soil Instruments Limited. Registered in England. Number: 07960087. Registered Office: 3rd Floor, 1 Ashley Road, Altrincham, Cheshire, WA14 2DT, UK

VIBRATING WIRE INSTRUMENTS CALIBRATION CERTIFICATE

Instrument Type : W9 Vibrating Wire Piezometer	Serial No. : 054883
Instrument Range : 0.00 to 500.0 kPa	Calibration Date : 05/04/2016
Gauge Factors in kPa	Ambient Temperature : 24°C
Period Gauge Factor (K): 3268.0610000	Barometric Pressure : 1004 mbar
Linear Gauge Factor (G): (kPa/digit)0.3268100	Calibration Technician : Wayne Diprose
Polynomial Gauge Factor A: -0.000001316427000	Calibration Equipment: Mensor APC 600 AVW200 Data Logger
Polynomial Gauge Factor B: -0.3118874000	
Polynomial Gauge Factor C**: 2060.205000	Regression Zero : 6432.5

Applied (kPa)	Reading (Period)	Reading F ² /1000	Calculated (Linear)	Error %FS (Linear)	Linear Increment	Calculated (Polynomial)	Error %FS (Polynomial)
0.00	3943.3	6431.0	0.475	0.10	0.0	0.013	0.00
50.00	3990.8	6279.0	50.150	0.03	-152.0	49.963	-0.01
100.00	4040.1	6126.4	100.020	0.00	-152.6	100.049	0.01
150.00	4091.3	5974.1	149.793	-0.04	-152.3	149.976	0.00
200.00	4144.6	5821.4	199.696	-0.06	-152.7	199.972	-0.01
250.00	4200.3	5668.2	249.763	-0.05	-153.2	250.071	0.01
300.00	4258.0	5515.6	299.634	-0.07	-152.6	299.911	-0.02
350.00	4318.5	5362.0	349.831	-0.03	-153.6	350.017	0.00
400.00	4381.8	5208.4	400.028	0.01	-153.6	400.060	0.01
450.00	4447.7	5055.0	450.160	0.03	-153.4	449.976	0.00
500.00	4517.0	4901.1	500.456	0.09	-153.9	499.993	0.00

Formulae: Linear* E = G(R0 - R1)
 Polynomial** E = AR² + BR1 + C

* The zero reading should be established on site by the user on installation.
 ** The site value of C must be calculated using the formula C = -(AR⁰ + BR0)

The instrument detailed herein has, as applicable, been tested and calibrated in accordance with procedures, which are part of our ISO 9001:2008 Quality Management System, and unless otherwise indicated, performs within ± 0.10% (Polynomial) as specified. Thus, the instrument conforms in all respects to our relevant specifications and drawings.

Certified:  Line MANAGER

Calculation of engineering units from frequency readings of VW sensors

The mathematical relationship between the resonance frequency of a tensioned wire and the force applying the tension is represented by a near straight line relationship between the square of the frequency (Hz²) and the applied force.

The sensor readings in frequency can be converted to measurements in engineering units (such as mm, kPa or psi) using the following equations:

CALCULATION USING LINEAR EQUATION

The following equation is used for readings in Hz²/1000:

$$E = G \times (R0 - R1)$$

where:

E is the resultant Engineering unit

G is the linear Gauge factor for the units of calibration

R0 is the 'base' or 'zero' reading (in Hz²/1000) taken at the time of installation

R1 is the current reading in Hz²/1000.

CALCULATION USING POLYNOMIAL EQUATION

The polynomial formula for all Soil Instruments VW sensors is:

$$E = A \times R1^2 + B \times R1 + C$$

where:

E is the resultant value in Engineering units

A, **B** and **C** are the polynomial factors from the calibration sheet

R1 is the current reading in Hz²/1000

It should be noted that **C** is an offset value derived from a 'base' reading in the factory where the sensor calibration is performed. Soil Instruments recommend the value for **C** should be recalculated at the time of installation from the **R0** as follows:

$$C = - (A \times R0^2 + B \times R0)$$

VWnote allows you to enter either **C** or **R0** in the sensor configuration. If you choose to enter **R0**, the VWnote will recalculate the **C** for you before performing the raw to engineering unit conversion.

Appendix B – Frequently Asked Questions



What happens if I drop the VWnote unit?

The VWnote has been subjected to a drop test from a one metre height onto a concrete surface. The VWnote is supplied with a wrist strap so you can keep it attached to your wrist when there is a drop risk. Please make use of it to avoid drop damage.

What do I do if my reading is unstable?

Answer 1: It may be that you have too many digits after the decimal point when you display the reading. The default setting is one digit. You may need to adjust the Display Resolution (DISPL. RESOL).

Answer 2: When you encounter unstable readings, you should take another reading. If the problem persists, you should re-try using a narrower sweep frequency range.

Why am I getting a display of “No VW sensor?” or “No Therm Sen.?”?

This means no VW sensor or no thermistor sensor is connected, or the sensor or the signal cable is faulty. Check the sensor lead is properly connected and then check the signal cable and the sensors.

What sweep frequency range should I use to read my VW sensors?

In most cases, the default sweep frequency range (1400-3500 Hz) works well. Optionally, you can customise the sweep frequency to any range between 450 Hz and 6000 Hz, such as 450-1250 Hz or 1200-2800 Hz.

Will VWnote work at very low or very high temperatures?

The VWnote was tested and working after it had been in a temperature chamber for an hour at -10°C. At temperatures lower than -10°C, the LCD screen may become unreadable. The same test was conducted at +50°C and the VWnote functioned normally.

What unit is Hz²/1K?

Due to limited display space on the LCD screen, Hz²/1000 is displayed as Hz²/1K.

Why is my engineering unit displayed as ‘blank’?

Before you can set up sensor configuration with proper engineering unit names in the VWnote, the engineering unit will be displayed as ‘blank’, alerting you that it is not yet set.

SUPPORT

www.soilsupport.co.uk

+44 (0) 1825 765044



Bell Lane, Uckfield, East Sussex
TN22 1QL United Kingdom

t: +44 (0) 1825 765044 e: info@soilinstruments.com w: www.soilinstruments.com

Soil Instruments Limited. Registered in England. Number: 07960087. Registered Office: 3rd Floor, Ashley Road, Altrincham, Cheshire, WA14 2DT